

Seminar in delavnica

Načrtovanje elektronike za EMC

Merjenje EMC

Izr. prof. dr. Marko Jankovec

Univerza v Ljubljani

Fakulteta za elektrotehniko

Tržaška 25, SI-1000 Ljubljana, Slovenia

Sevalne emisije

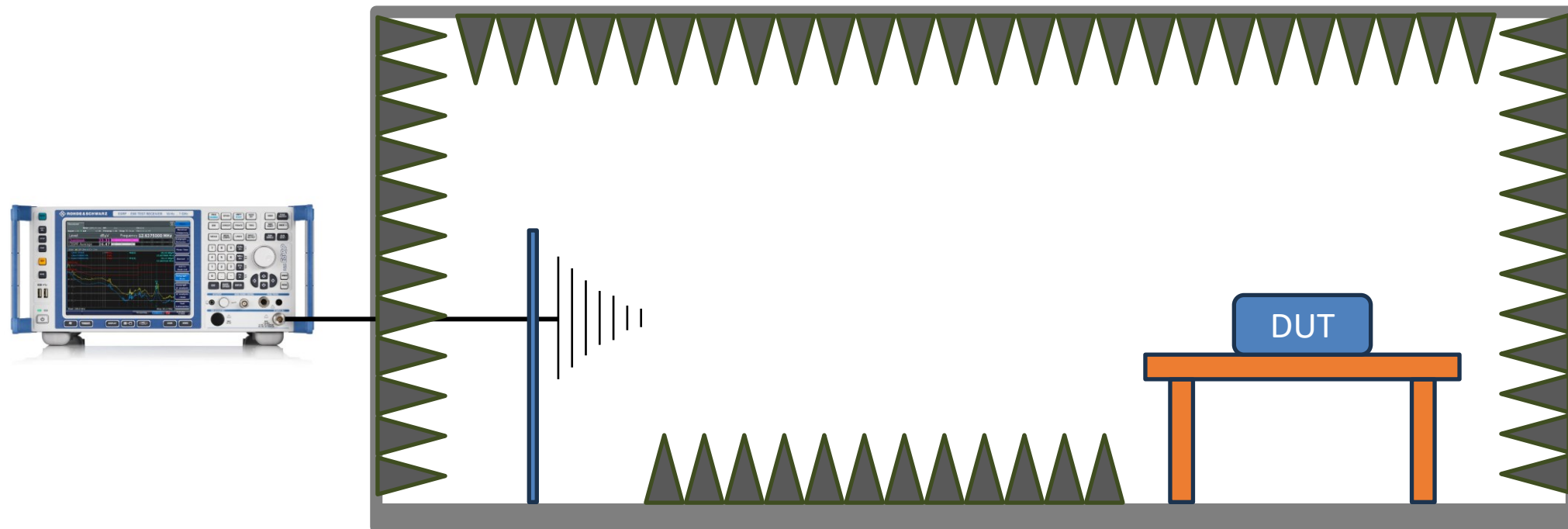

Sevalne emisije

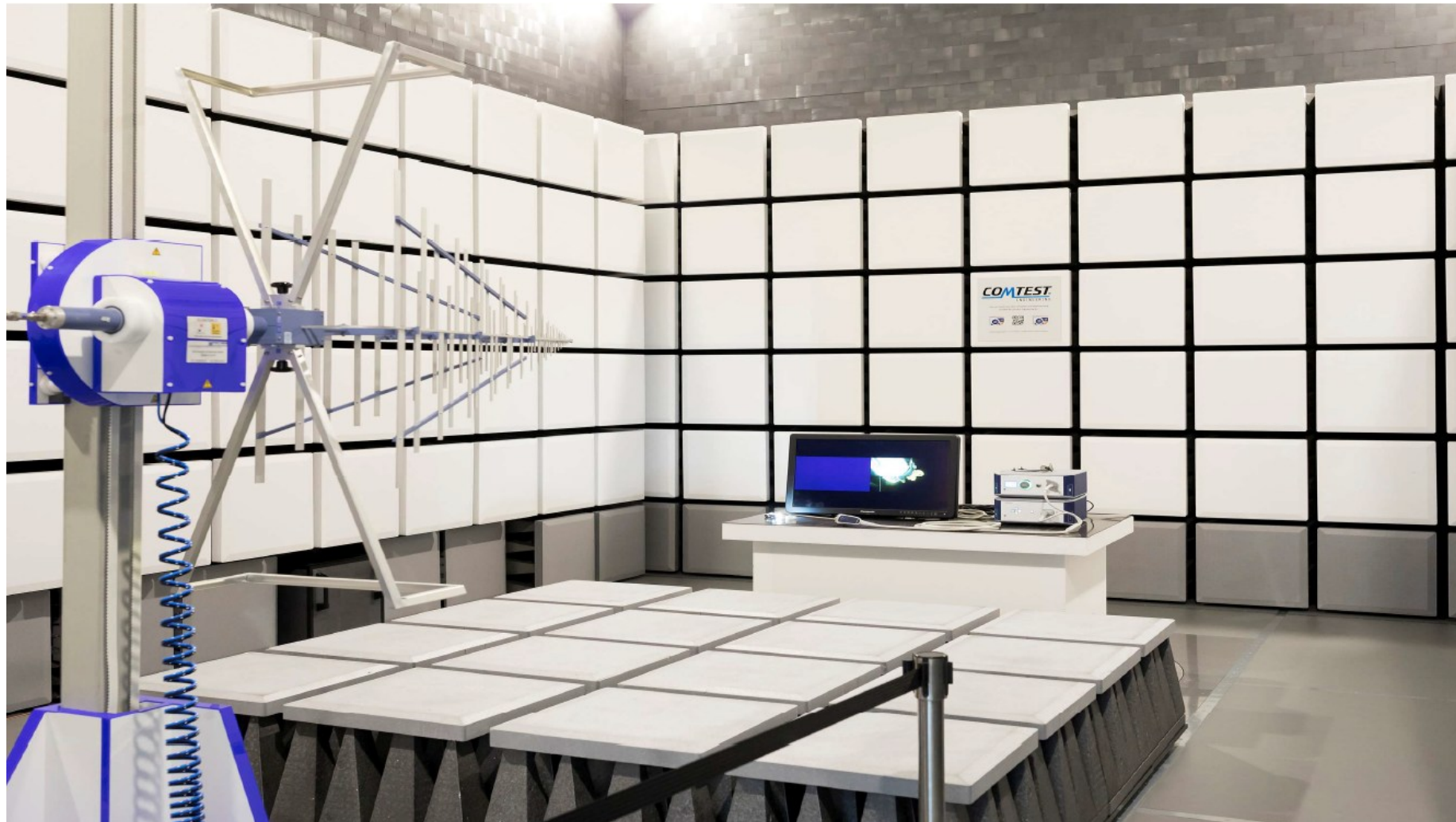

Merjenje sevalnih emisij CISPR25 150 kHz – 30 MHz

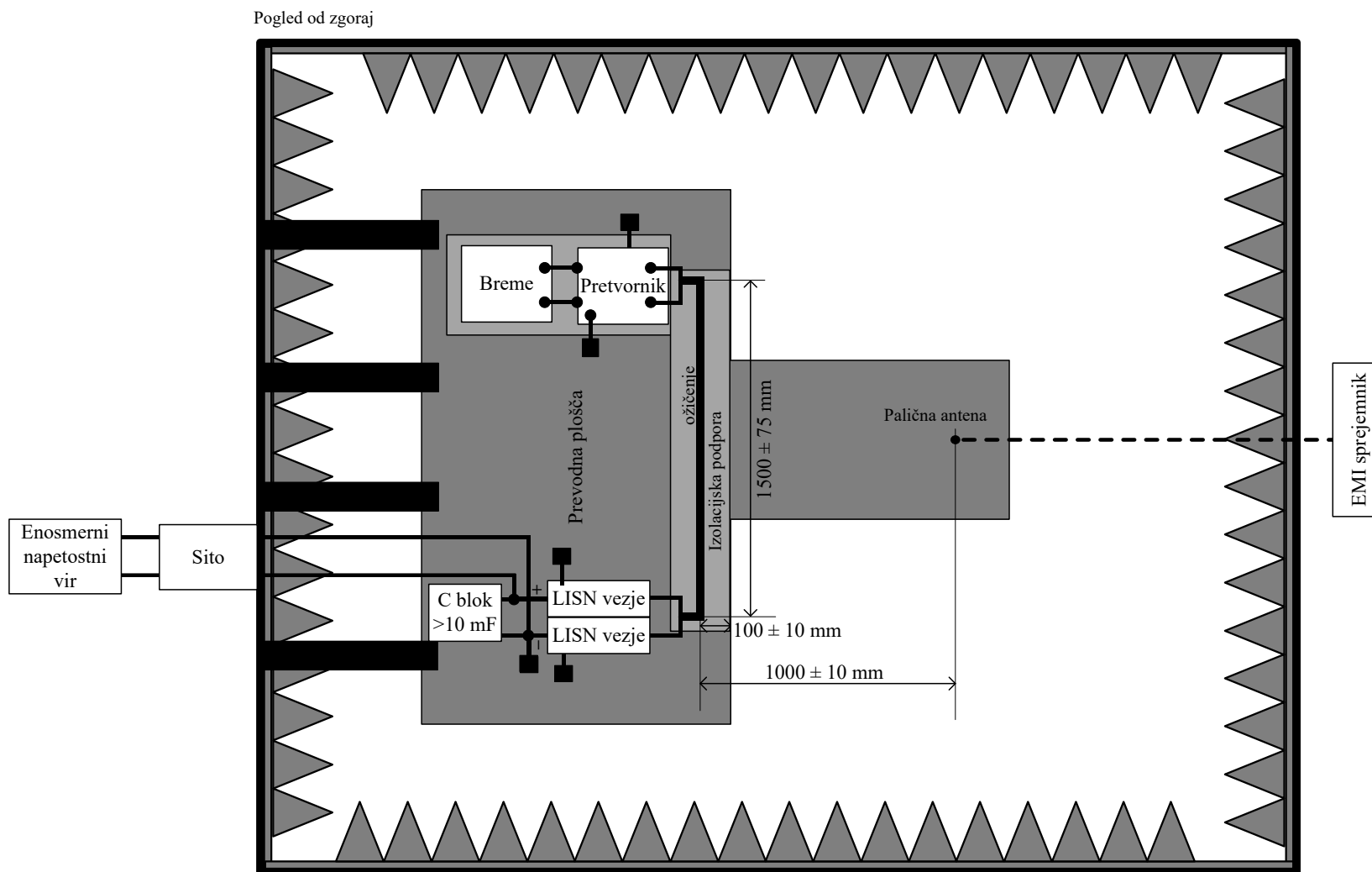

Merjenje sevalnih emisij CISPR25 30 MHz – 1000 MHz

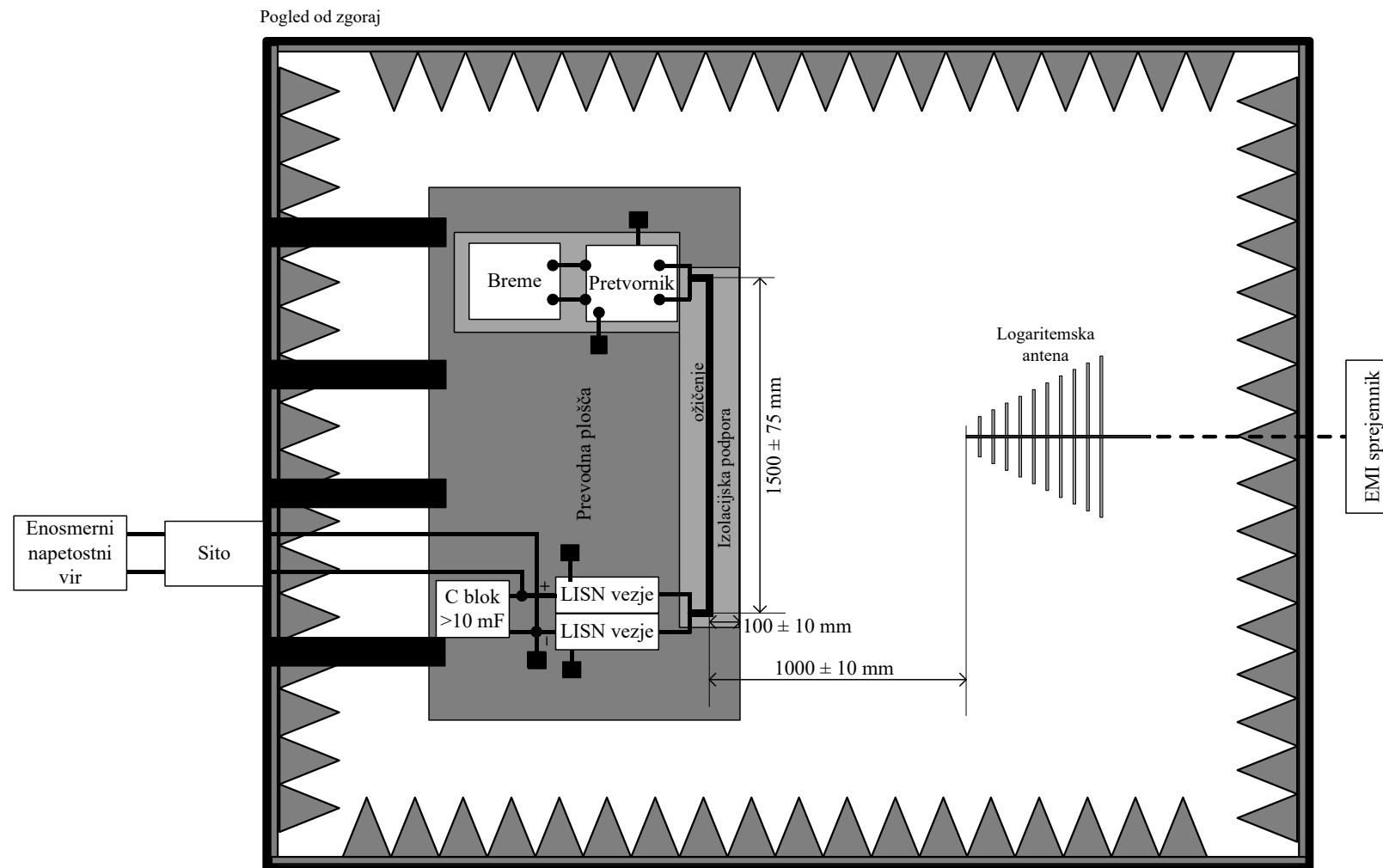

EMI sprejemnik

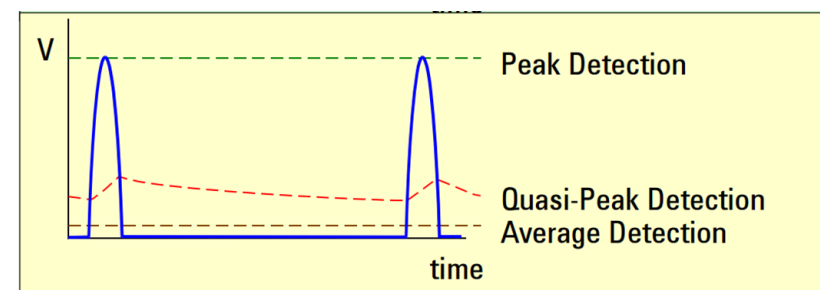
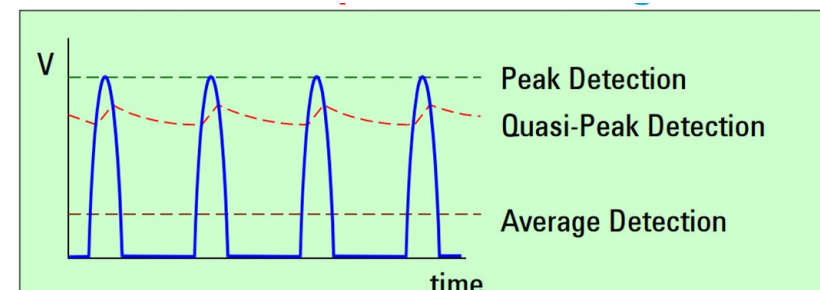
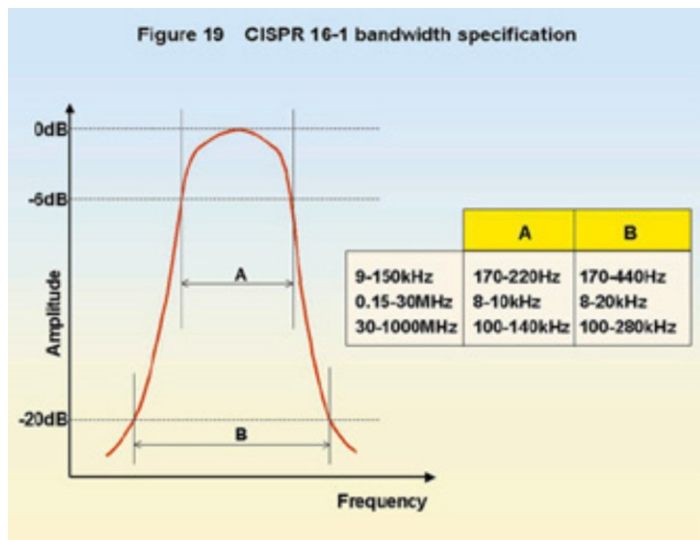
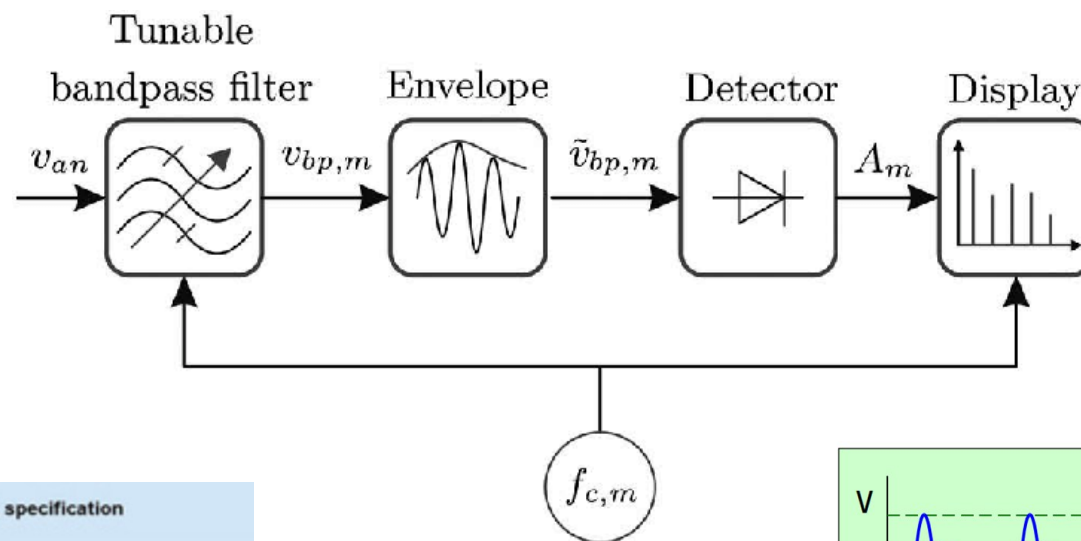

Meje sevalnih emisij CISPR25

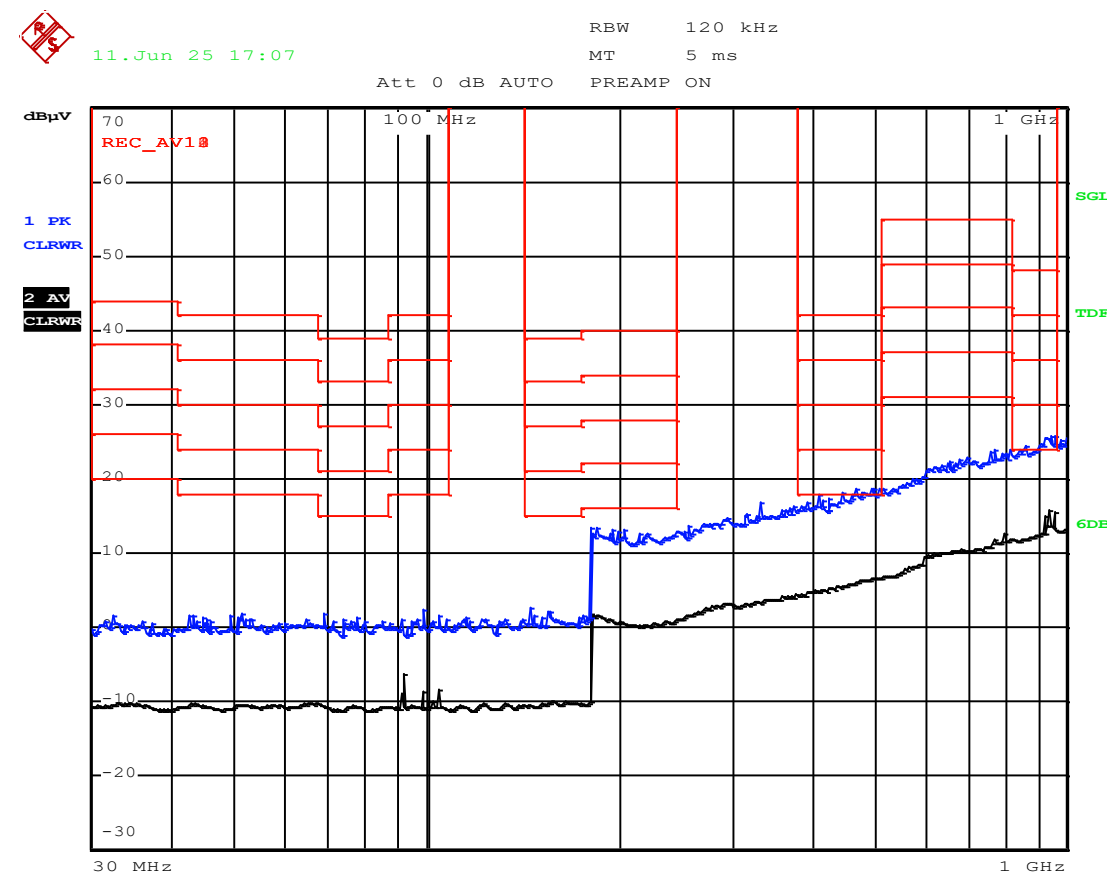
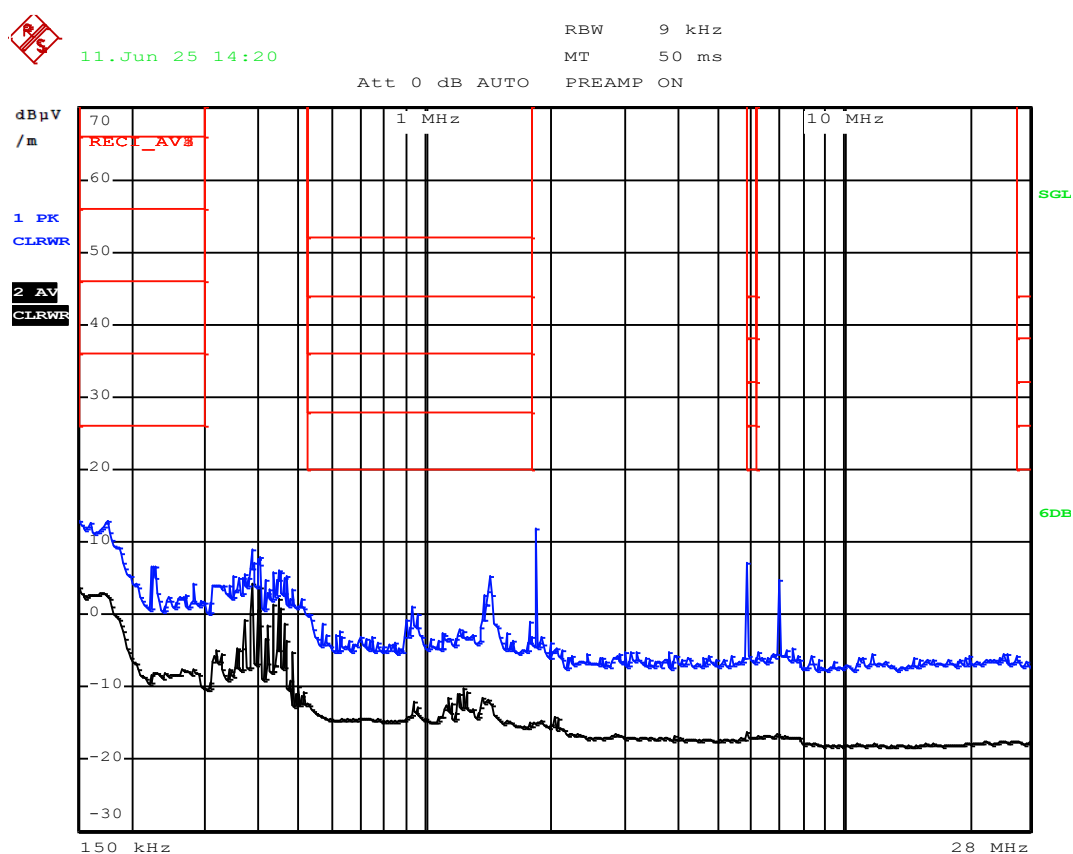

Sevalne emisije

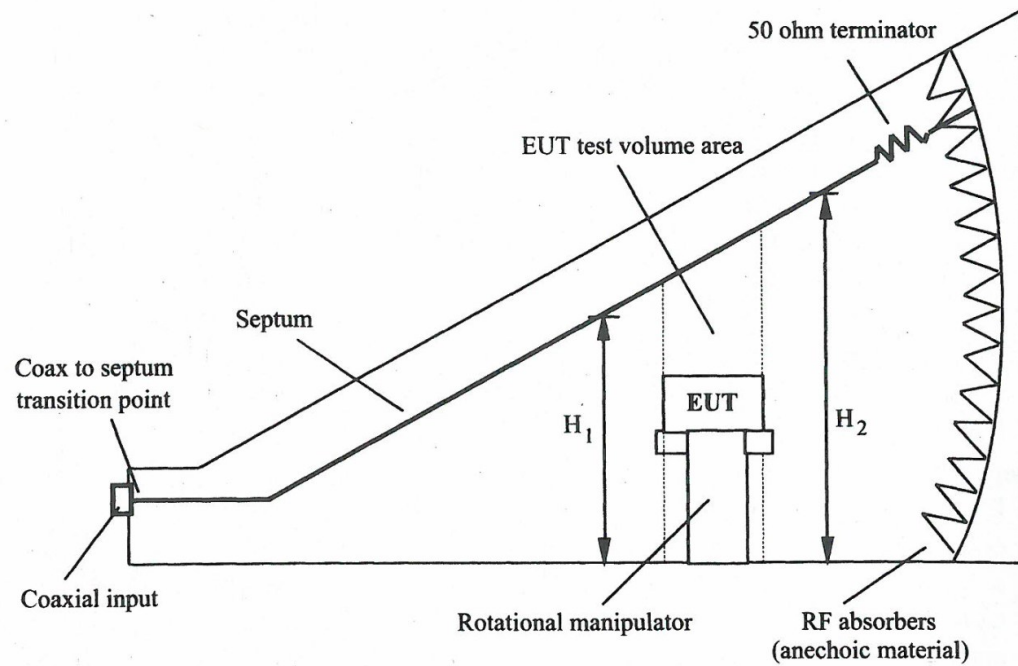

Domača merilna oprema

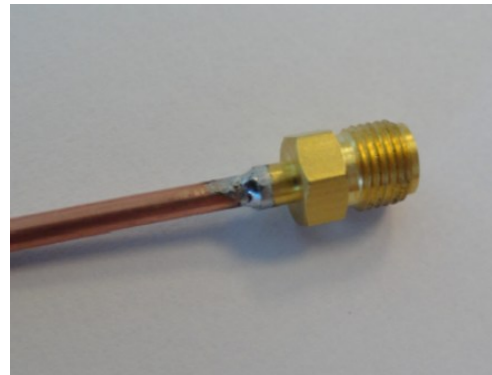
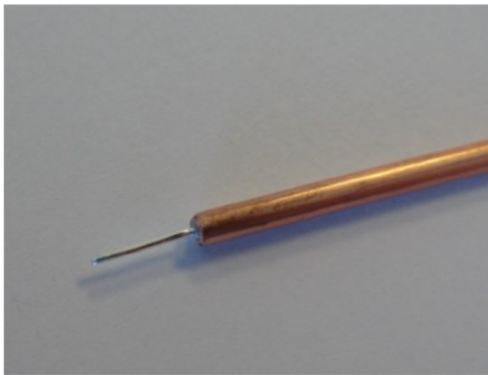
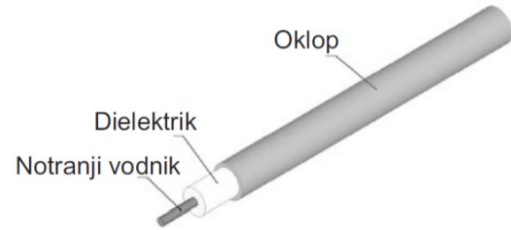
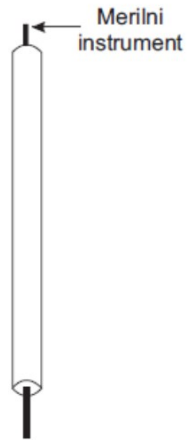

Osnovna zanka
A



Oklopljena zanka
B

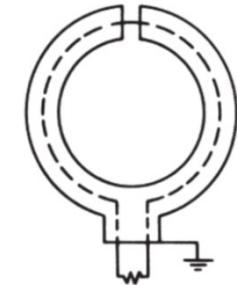

Oklopljena zanka z režo
C



Gjorgji Nusev, Diplomsko delo, 2014

Prevodne emisije

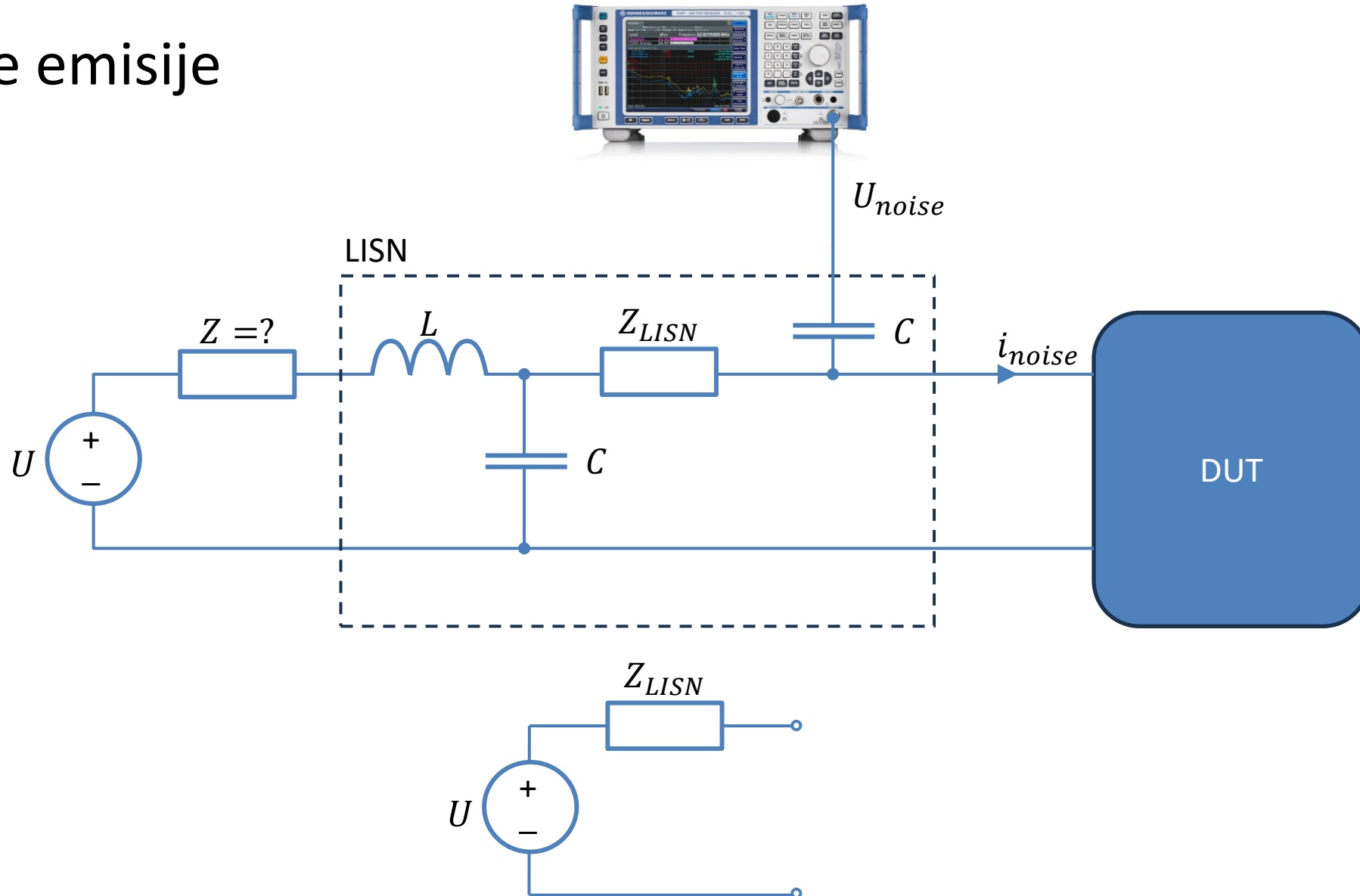

Merjenje prevodnih emisij CISPR25 150 kHz – 108 MHz

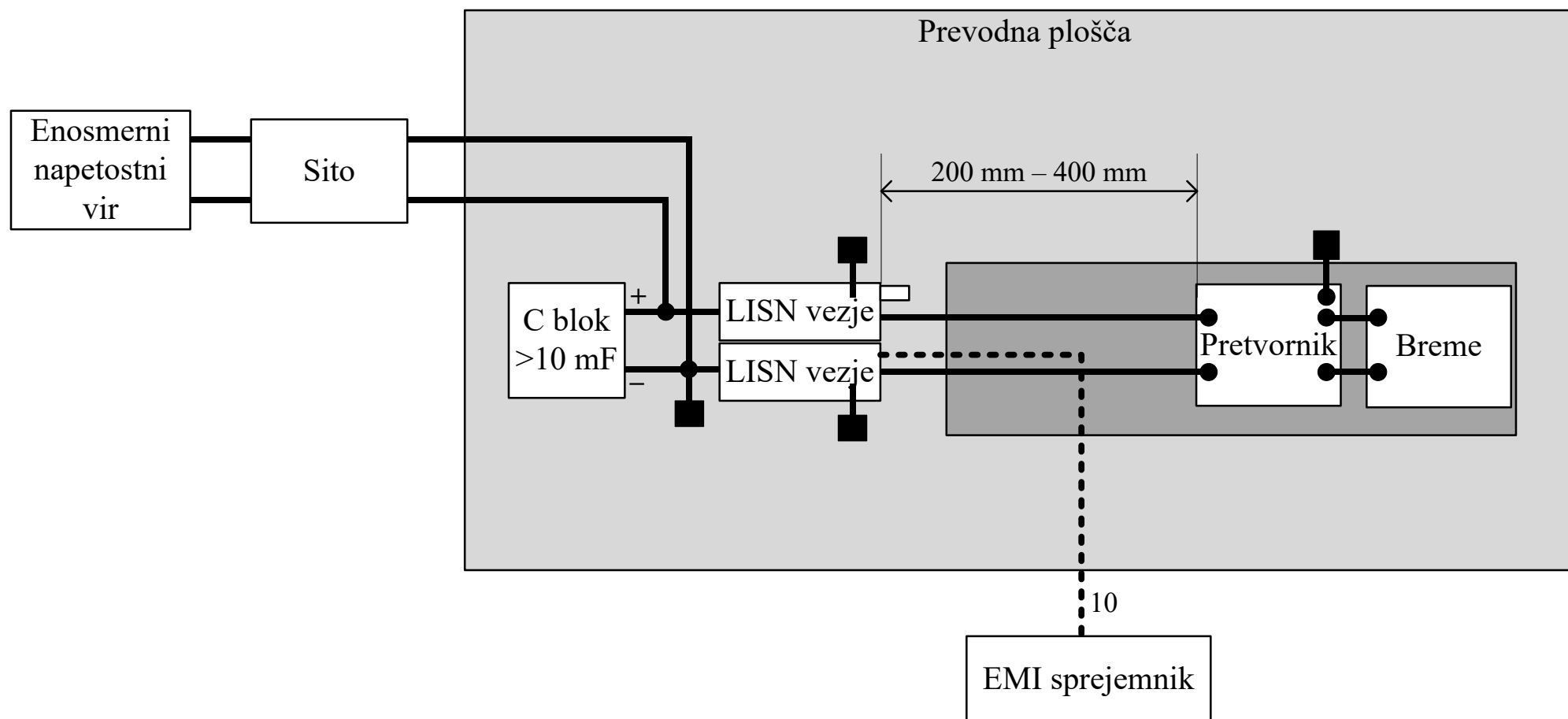

Meje prevodnih emisij CISPR25

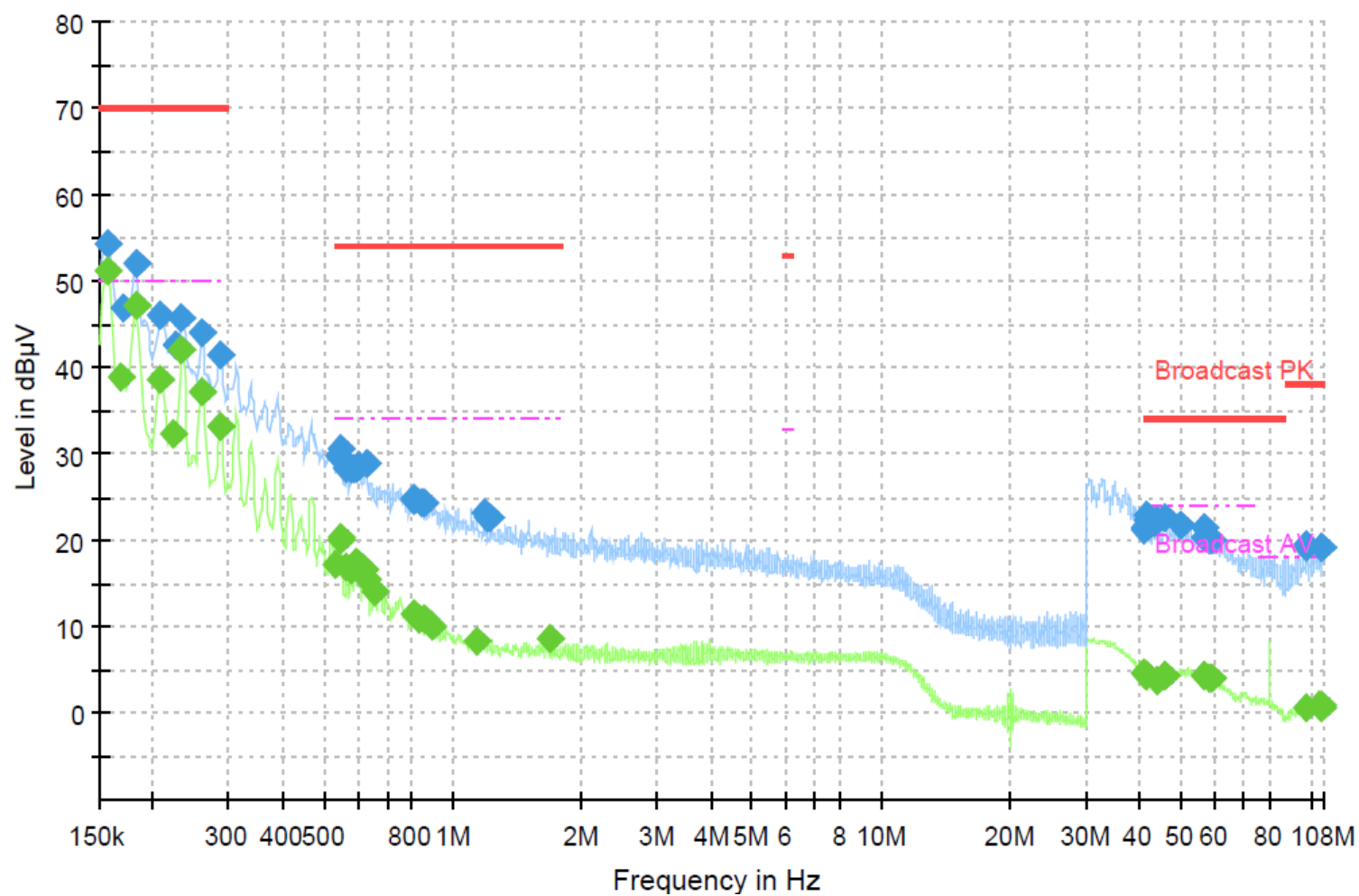

Domača merilna oprema

