

Seminar in delavnica

Načrtovanje elektronike za EMC

Detajli pri meritvi konduktivnih motenj

M. Jankovec

Univerza v Ljubljani

Fakulteta za elektrotehniko

Tržaška 25, SI-1000 Ljubljana, Slovenia



Primer celotnega sklopa

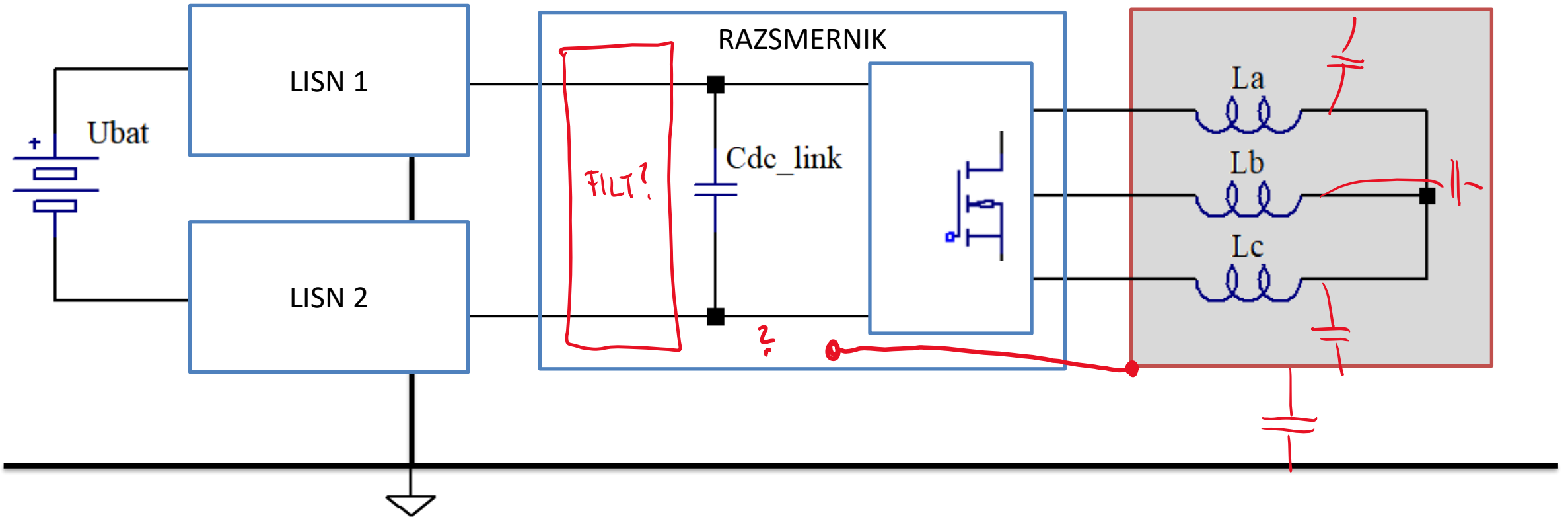

EMC meritve

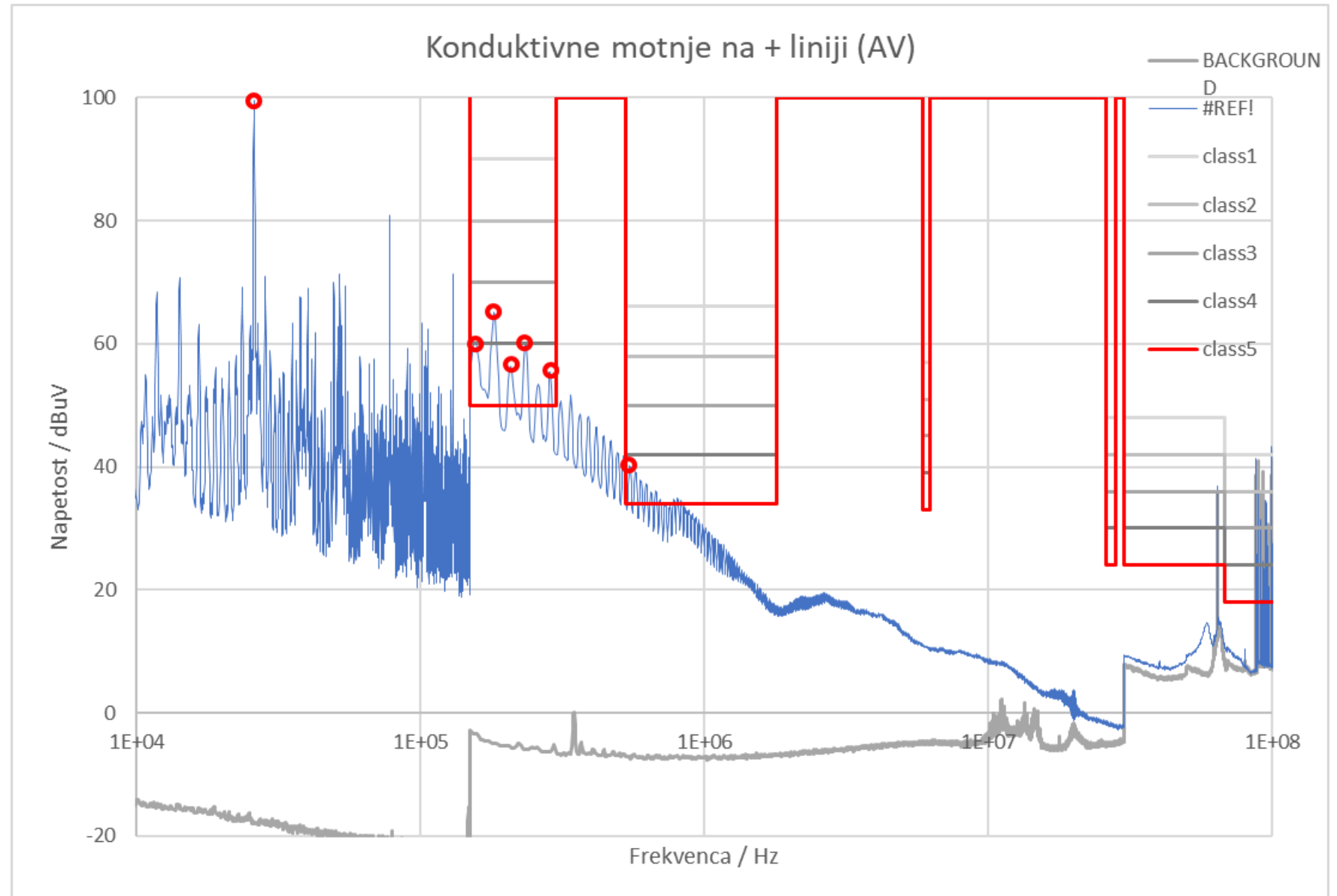

Primer izhodne stopnje razsmernika

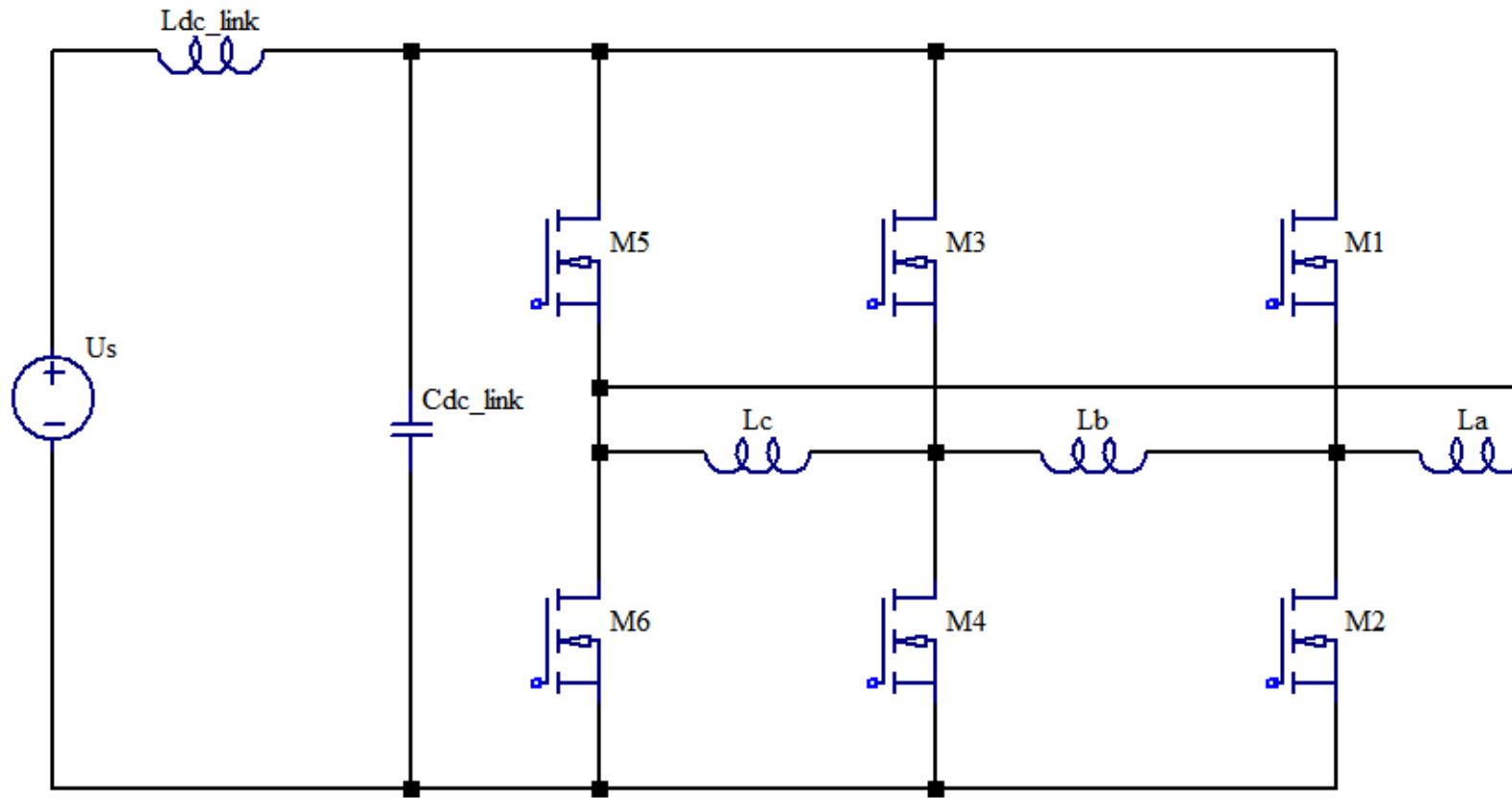

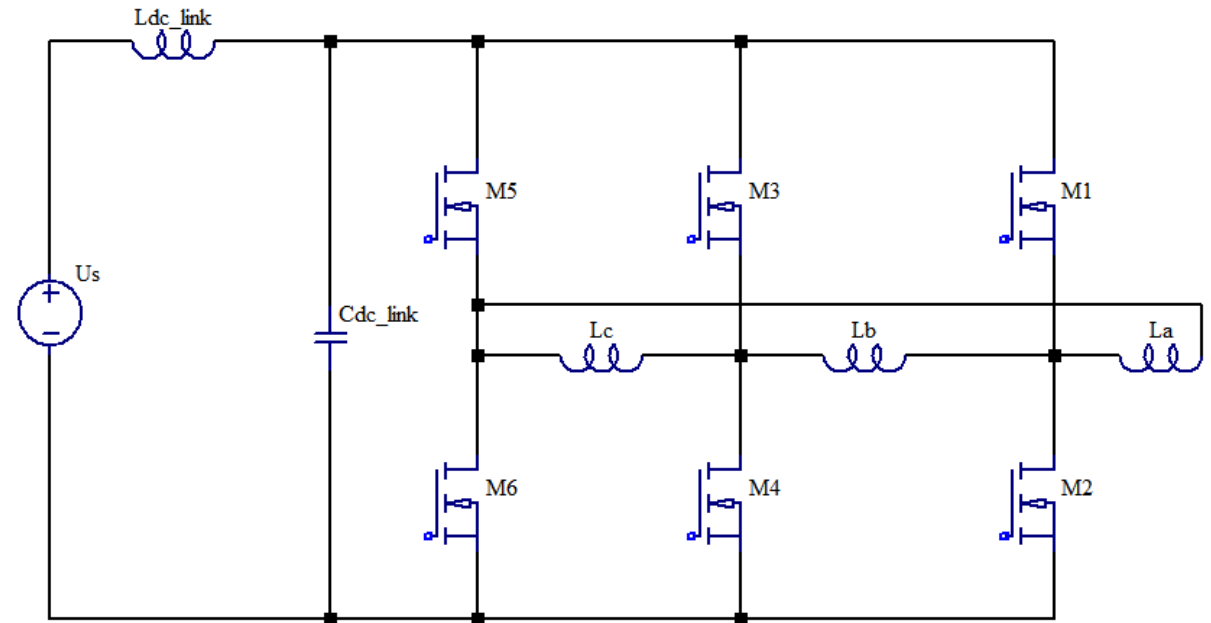
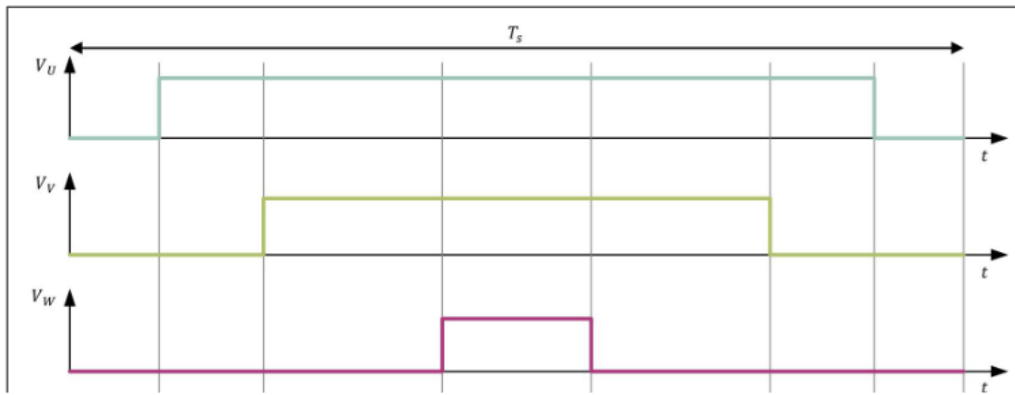
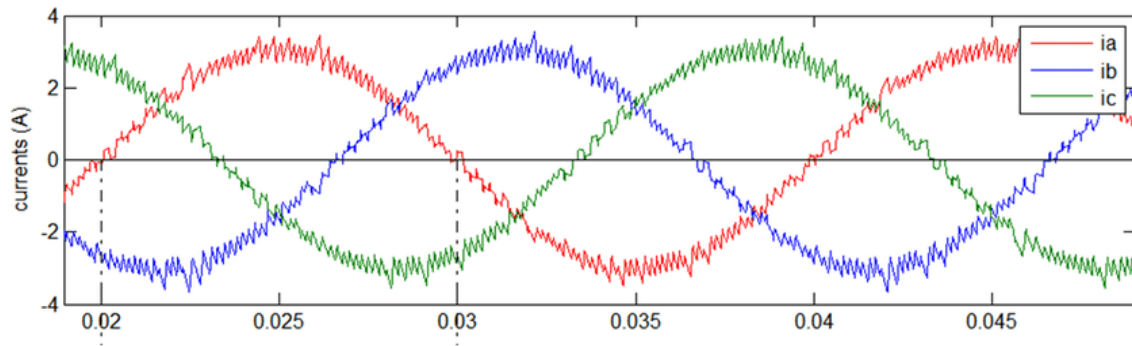

Fazne napetosti

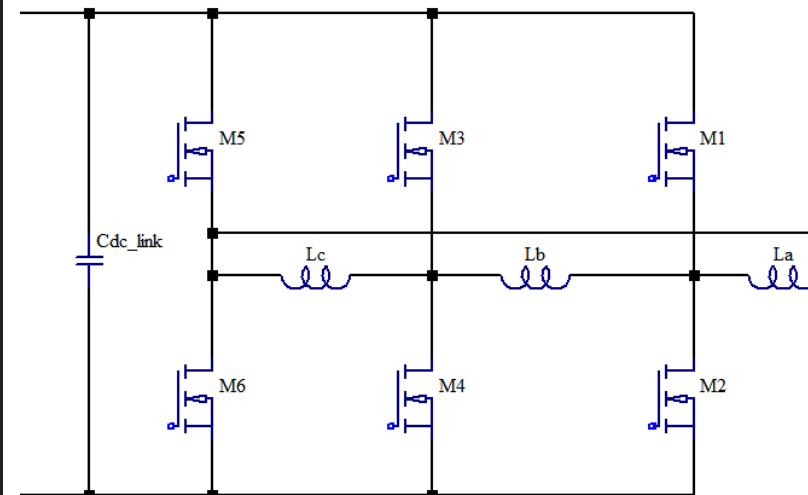
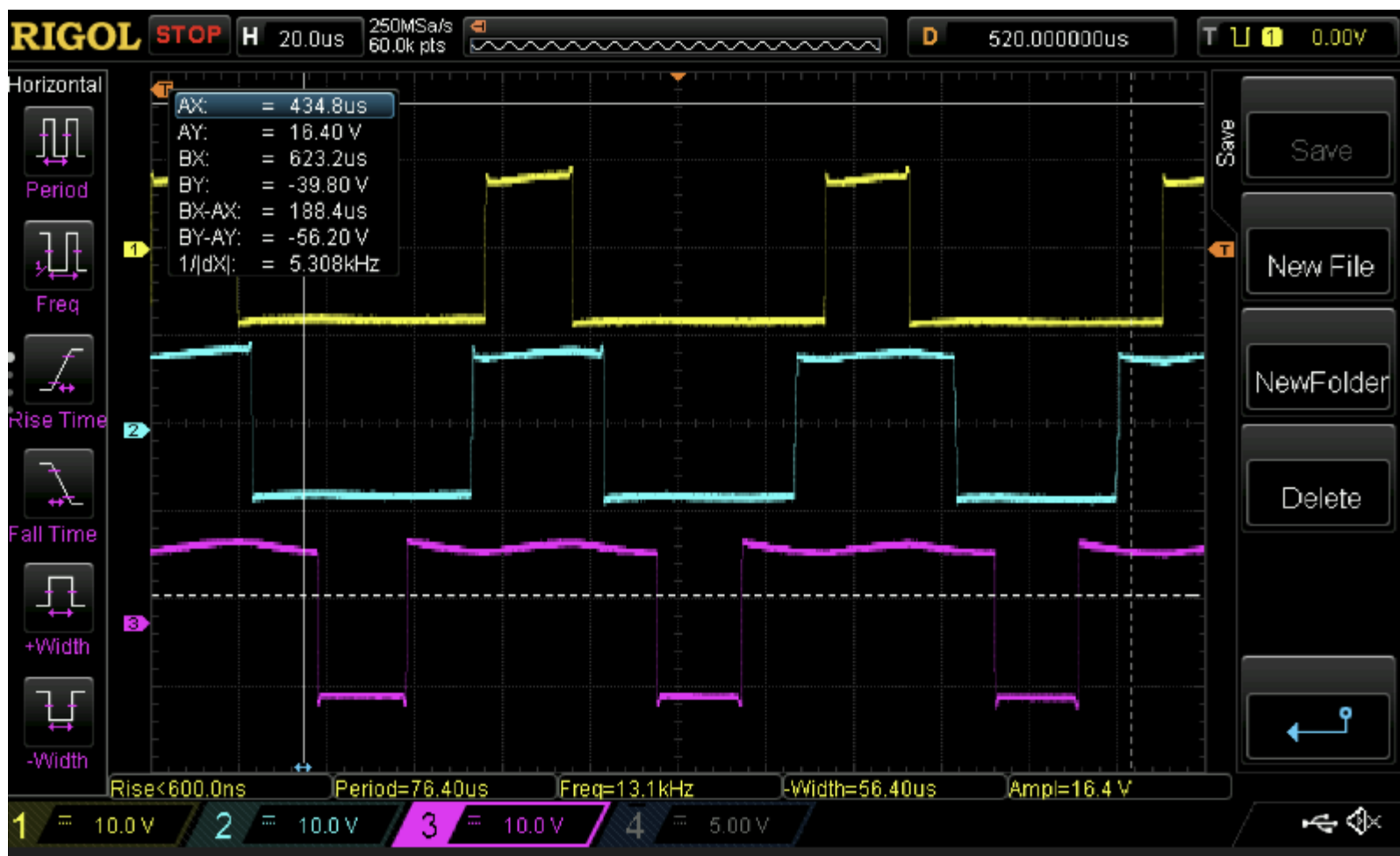

Konduktivne motnje

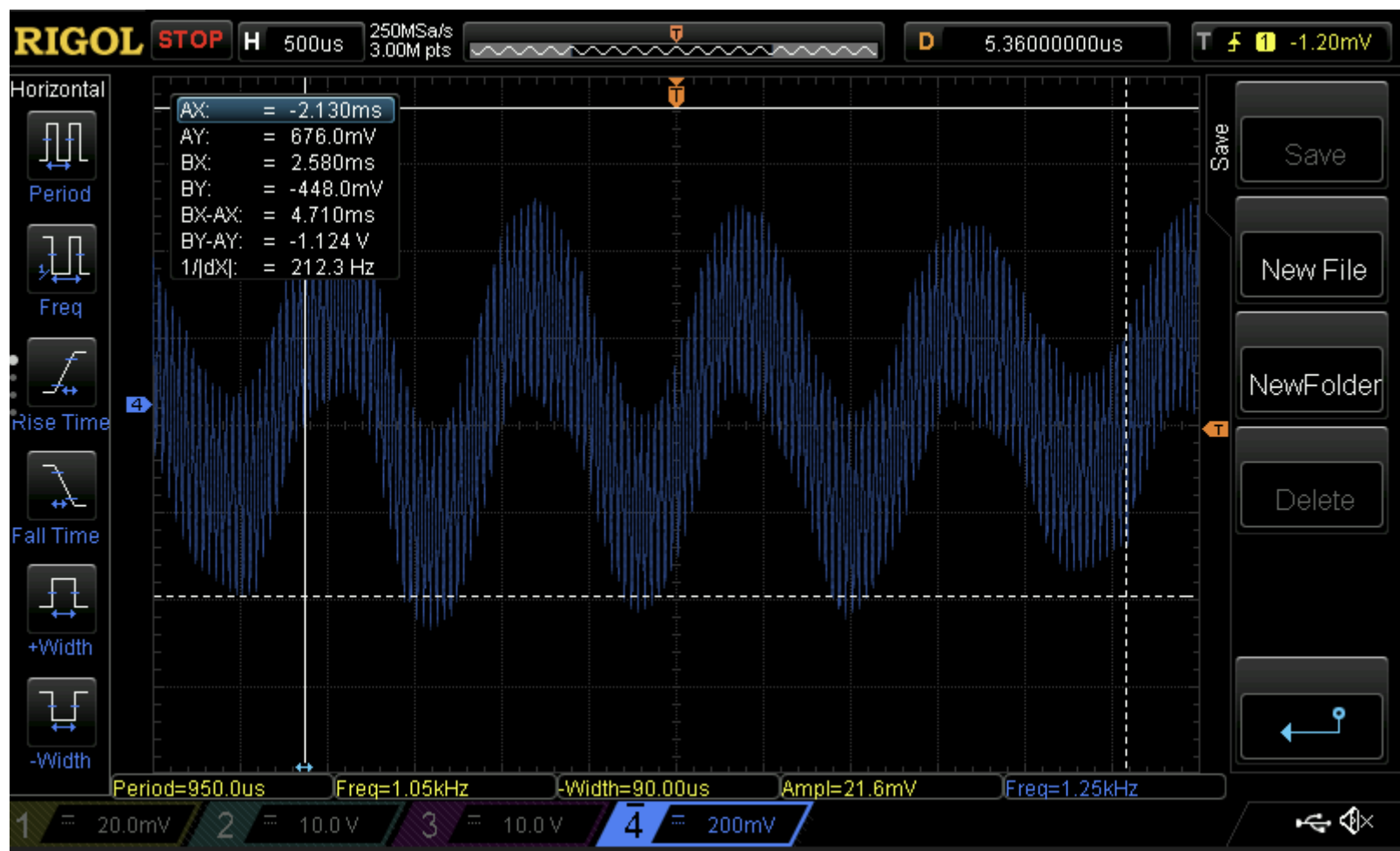

Konduktivne motnje (zoom)

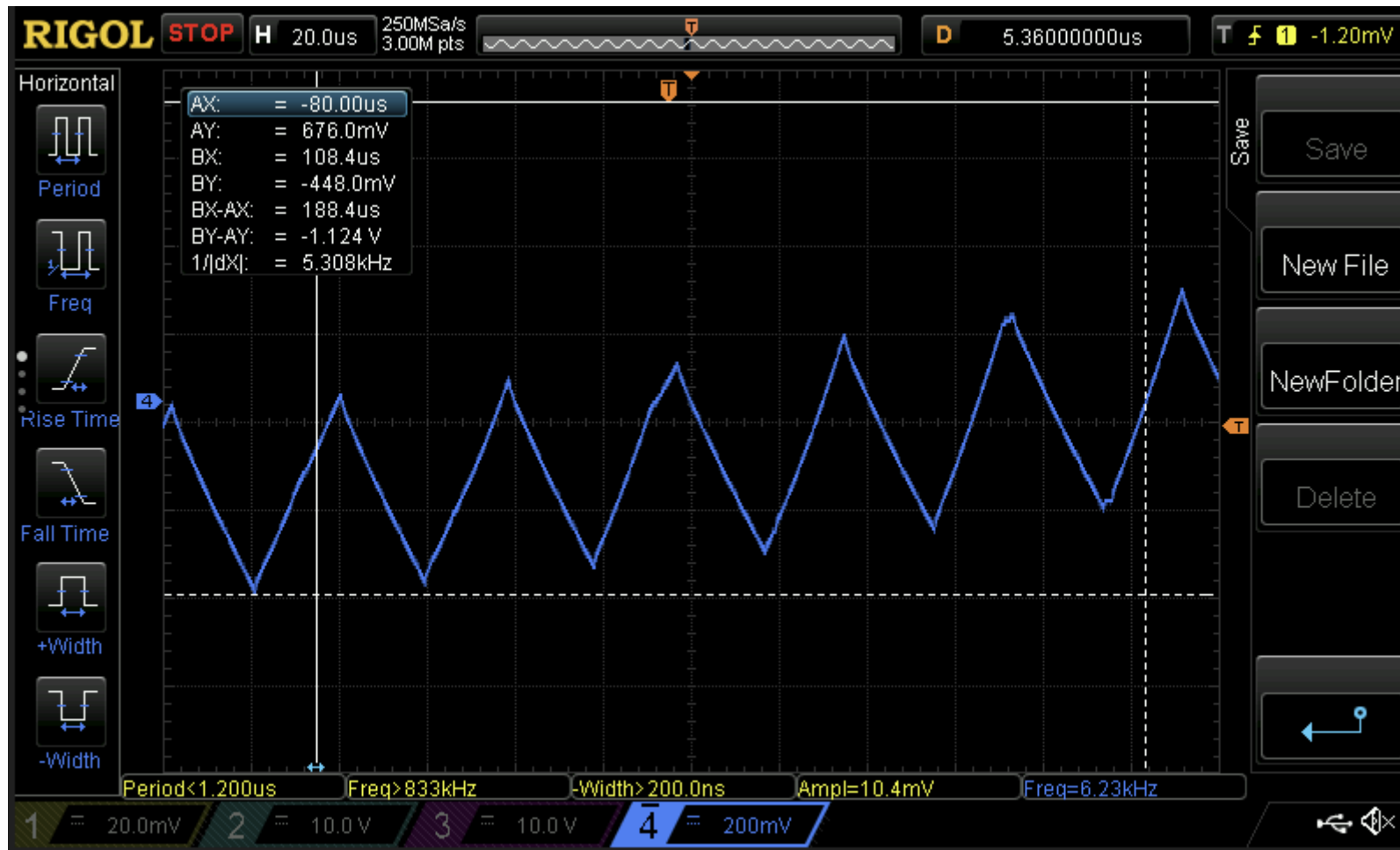

EMC meritve

Peaks		
frekvenca	amplituda	razlika nad m
26000	99,5	
156750	59,9	9,9
181500	65,24	15,24
208500	56,63	6,63
233250	60,09	10,09
287250	55,62	5,62
543750	40,39	6,39

Napoved amplitud naslednjih kor	
Frekvenca	Amplituda
26000	
181500	
543750	

