

Povezava na stran projekta
<http://lpvo.fe.uni-lj.si/izobrazevanje/seminarji/nacrtovanje-elektronike-za-emc/>

Vse testne tocke(TP) morajo biti na spodnji strani vezja

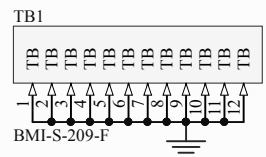
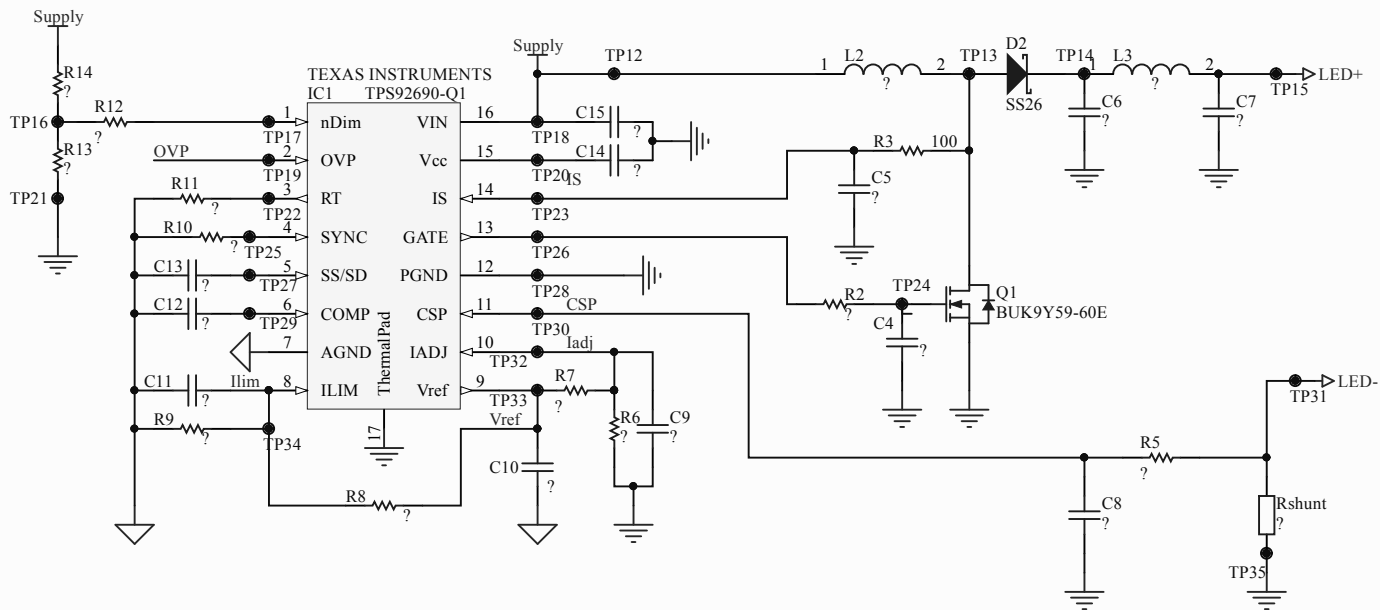
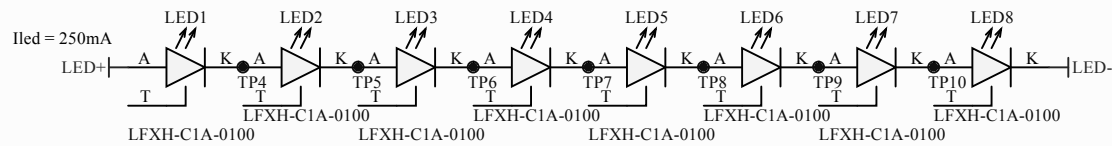
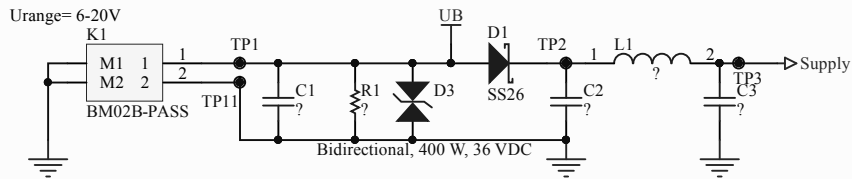

Design > Document options > Parameters > Author

LPVO Laboratorij za fotovoltaiiko
in optoelektroniko

Title Vezje za EMC tekmovanje			Fakulteta za elektrotehniko Trzaska 25 1000 Ljubljana EMC tekmovanje Ljubljana 2016	EMC
Size: A4	Author: Ime Priimek	Revision: 1		
Date: 17.3.2016	Time: 17:20:43	Sheet of		
File: D:\FE\Seminarji\Seminar in EMC tekmovanje 2016\Izziv\Altium\EMC FE 2016.SchDoc				

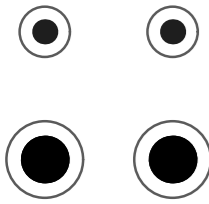

1C TO
SC OB
Ime Priimek

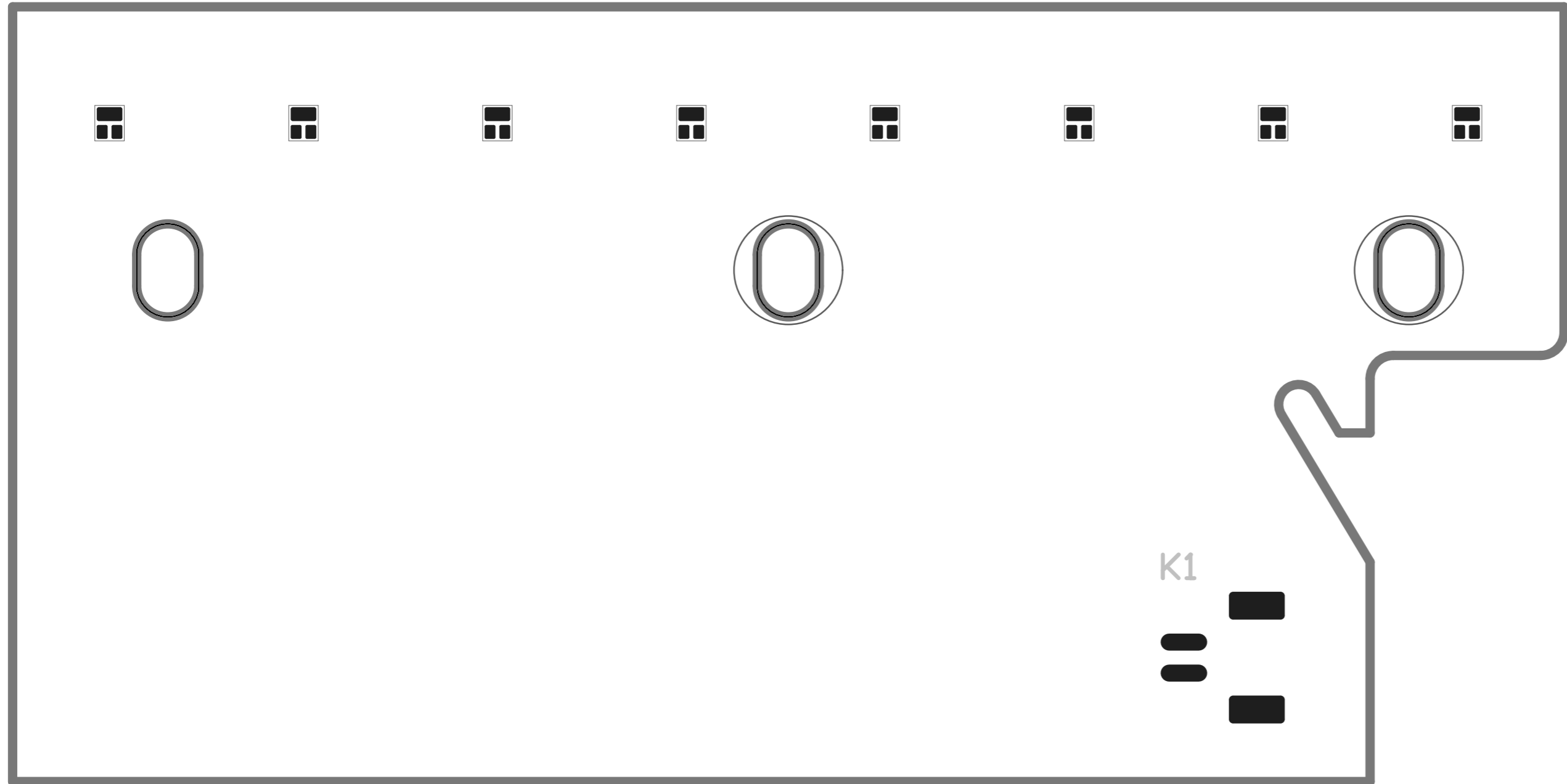

C3 C4 C7 C2 C1 C41 C1 C45 C1 C28 C10

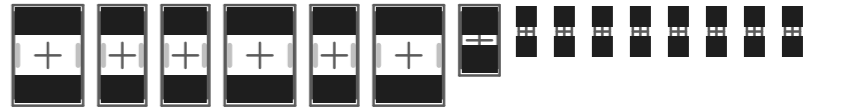

R1 R2 R3 R4 R5 R6 R7 R8 R9 R10



D3 Q1 L1 L3 L2 D1 D2



IC1

